

komfovent[®]



C4.1

EN Electrical installation and Operation Manual

Content

1. ELECTRICAL INSTALLATION MANUAL 4

 1.1. Electric Power Supply Connection 4

 1.2. Requirements for the installation of the control panel 4

 1.3. Kitchen Hood Connection 5

 1.4. External elements connection 5

2. C4.1 OPERATION MANUAL 7

 2.1. Unit control..... 7

 2.2. Control panel indication 7

 2.3. Operation modes selection 8

 2.4. Menu 8

 2.4.1. Overview 8

 2.4.1.1. Alarms 9

 2.4.1.2. Detailed information 9

 2.4.2. Scheduling 9

 2.4.3. Functions 10

 2.4.3.1. Setpoint sliding 10

 2.4.3.2. OVR function 10

 2.4.4. Settings 11

 2.4.5. Unit switching on or off..... 11

 2.5. Configuration of automation functions 11





 2.6. Troubleshooting 12



This symbol indicates that this product is not to be disposed of with your household waste, according to the WEEE Directive (2002/96/EC) and your national law. This product should be handed over to a designated collection point, or to an authorised collection site for recycling waste electrical and electronic equipment (EEE). Improper handling of this type of waste could have a possible negative impact on the environment and human health due to potentially hazardous substances that are generally associated with EEE. At the same time, your cooperation in the correct disposal of this product will contribute to the effective usage of natural resources. For more information about where you can drop off your waste equipment for recycling, please contact your local city office, waste authority, approved WEEE scheme or your household waste disposal service.



1. ELECTRICAL INSTALLATION MANUAL

Installation works can be performed only by the specialists that have required qualification. During installation following requirements must be fulfilled.

-  It is recommended to lay control cables separately from power cables in a distance no less than 20 cm.
-  Connector connection is performed strictly according to numeration given in wiring diagram, or adequate markings (see wiring diagram).
-  When disconnecting unit sections, do not pull by connecting wires and cables!
-  Before starting any operations inside the unit, make sure that the unit is switched off and the power supply voltage is shut off.

1.1. Electric Power Supply Connection

Air handling unit voltage is 230 V AC; 50 Hz, therefore it is necessary to install the socket with grounding of corresponding capacity (see wiring diagram). Electric power supply cable type is indicated in electric diagram.

-  All units must be connected to the stationary installation by solid cable through 10A circuit breaker with 300 mA current leakage protection (type B or B+).
-  Before connecting unit to the electrical power supply, it is necessary to check whether earthing has been installed properly in conformance with electric safety requirements.

1.2. Requirements for the installation of the control panel

1. The control console should be installed in a room where the following conditions are ensured:
 - 1.1. ambient temperature: 0 °C ... 40 °C;
 - 1.2. relative humidity range: 20 % ... 80 %;
 - 1.3. protection against dripping of water (IP X0).
2. Control panel connection is provided through a hole in the back or bottom side.
3. The panel can be mounted on a flush mounting box or in any other place just screwing two holes on the fastening surface.
4. The control panel is connected to the controller box. The length of the cable for connecting the panel with the unit may not exceed 150 m.

-  Do not use any other type or size screws but those that are packed together for control panel mounting. Wrong screws may damage electronics board.

Control panel connection

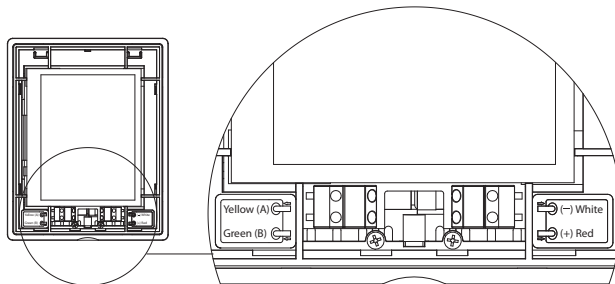

1.2 Picture

- ⚠ Control panel connection and other cable thicknesses are specified in the wiring diagram!
- ⚠ Remove protective screen tape, before mounting front cover on the control panel!

1.3. Kitchen Hood Connection

Air handling units DOMEKT R 200 V have possibility of kitchen hood connection (in the functional diagram it is marked by KH). After fishing the cable through the rubber gasket, (located in the wall) it has to be connected to connection box J11 (1.3 Picture).

Kitchen Hood Connection

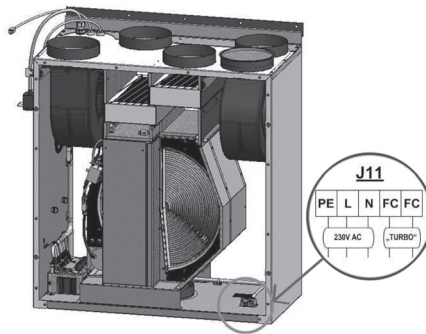

1.3 Picture

1.4. External elements connection

Depending on the model of Domekt air handling unit and component parts, several additional cables can be led outside the unit for connecting external elements of the automatics:

- **External control contacts.** They are designed in all Domekt units. Outside the unit, a cable is led (see Picture 1.4 a), to which an external control device (switch, sensor, timer, button, etc.) can be connected, i. e. interconnection of normally open contacts (short circuit) will activate the OVR function. A more detailed description of connection possibilities is presented in Chapter 2.6.



1.4 a Picture

- **External control box.** If a water heater or a cooler is designed in the Domekt unit, then the unit is fitted with an external control box (see Picture 1.4 b), which is connected to the unit with a JW1 cable. Some elements specified below are connected to the contacts of the box.



The connection diagram of the external elements is presented on the internal side of the doors of the control box.

- **Air damper actuator.** Domekt air handling units can be ordered with the prepared connection for air damper actuators. In this case, an additional cable is led outside the unit. 230V AC supply and control voltage is provided for the connection of the actuator.

Note: For units with water heater the connection of air damper actuators is designed from the external control box; therefore, connection should not be ordered additionally.



For all units with a water heater, it is recommended to connect an actuator with a spring-return mechanism, i. e. in the case of loss of voltage, the actuator should close the air damper.

- **Supply air temperature sensor.** At units with an electrical heater, the sensor is factory-installed inside the unit. At units with a water heater or a cooler, the sensor is mounted outside; therefore, it is necessary to install it in the supply air duct downstream the water heater (cooler) section. The minimum distance from the air vent of the section to the sensor should be at least two diameters of the circular connection.
- **Return water temperature sensor.** It is connected to the external control box and is mounted on the return water pipe by screwing it into the designated vent. It is recommended to thermally insulate the sensor.
- **Heating/cooling valve actuator.** It is connected to the external control box. For hot/cold water mixing, it is provided connection for actuator with 24 V AC supply voltage and 0...10 V DC control signal.
- **Circulation pump.** It is connected to the external control box. 230 V AC supply voltage is provided. The pump is started up/shut down by the circuit breaker QF1.
- **Feedback signal for heating or cooling.** It is connected to the external control box. By default, the air handling unit is designed to operate with the water heater. However, the design of the control box provides for two terminals, by interconnecting (short-circuiting) of them the heater mode is reversed to the cooler mode.



When the operation of the unit is switched over to the cooler mode, water freezing protection is deactivated. Therefore, when the unit operates in the cooling mode during the winter season, it is necessary to ensure that the water contained in the heater does not freeze.

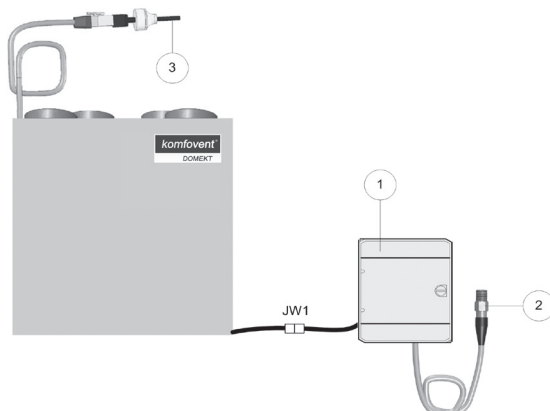

1.4 b Picture

- 1 – external elements control box
 2 – return water temperature sensor
 3 – supply water temperature sensor

2. C4.1 OPERATION MANUAL

2.1. Unit control

Air handling units control system ensures control of the physical processes that are taking place inside the air handling unit.

Control system consists of:

- controller module;
- temperature sensors and control panel, which can be installed in the convenient place for the user.

Control panel (2.1 Picture) is designed for remote air handling unit control, setting and display of controller parameters.

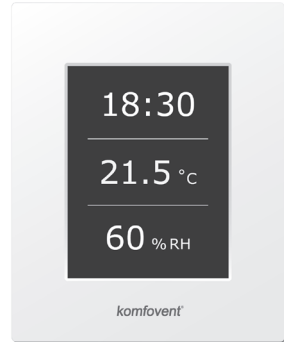

2.1 Picture. Control panel

2.2. Control panel indication

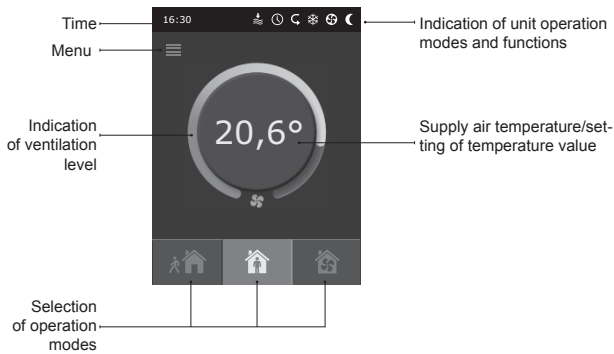

Explanation of the displayed symbols:

	Setpoint sliding (the value increases)		Air heater operation
	Setpoint sliding (the value decreases)		Air cooler operation*
	Supply air		Weekly operation mode
	Extract air		„Override“ mode
	Fan operation		Alarm signal
	Energy recovery operation		

* Air handling unit is provided with air cooling function. However, cooling should be ordered in advance. Then outside the unit will be installed additional control cable, and for supply air cooling will be added duct coil DCW (in case of water cooling) or duct coil DCF with outside cooling unit (in case of DX cooling). Cooling control is provided by 0...10V signal.

2.3. Operation modes selection

Three operation modes are possible, one of them user can directly select from control panel main window:

- Away;
- Home;
- Boost.

The mode is selected by tapping one of modes buttons located in the main window. The corresponding button becomes black, when the selected mode is activated. The user can set ventilation intensity separately for supply and extract air in each operation mode. Ventilation intensity mode window is opened by pressing and holding one of modes buttons. The supply air temperature is set by tapping round button in the centre of main window.

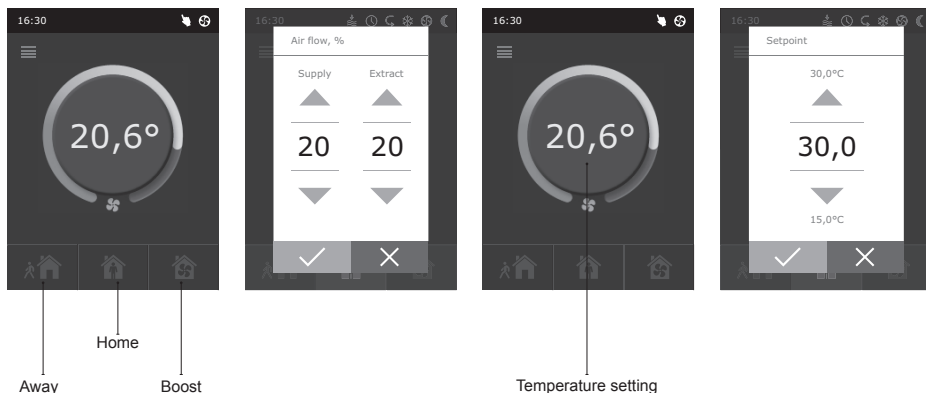

2.4. Menu

Menu of panel consists of the five points:

- Overview;
- Scheduling;
- Functions;
- Settings;
- On/Off.

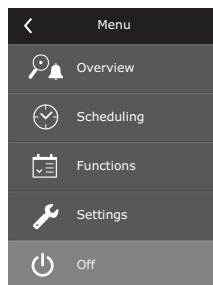

2.4.1. Overview

All information, relating to the operation and alarms of the unit, is detailed in overview menu.

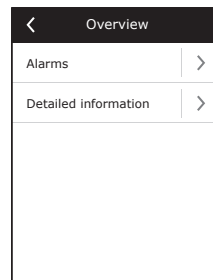

2.4.1.1. Alarms

This menu displays the notification of existing faults. After failure elimination (see chapter 2.6), messages are deleted by selecting "Delete". By clicking on „History“ can be viewed up to 50 registered alarms.

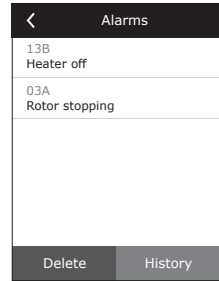

2.4.1.2. Detailed information

All temperature sensor readings, functioning of separate air handling unit elements and other detailed information is available in this menu.

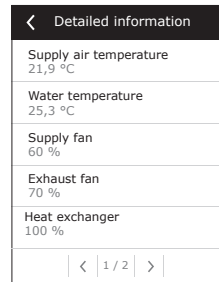

2.4.2. Scheduling

Menu for planning of the air handling unit operation according to the weekly program.

Three events can be set up for every week day. One of three modes can be assigned to each event. Every event has a timing, when the selected mode should be active. The timing is set by tapping "Start" and "Stop". When the mode "Standby" is selected, the fans are stopped and the unit is inactive until the next event.

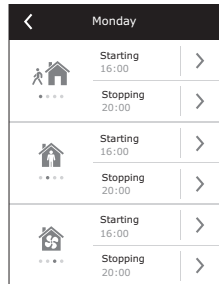
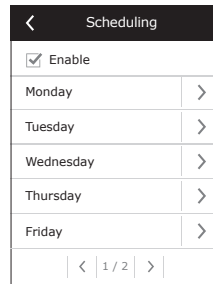

Example:

Monday:

07:30 – 11:00 Away mode is active

11:30 – 16:00 Home mode is active

16:00 – 17:00 Boost mode is active

The rest of the day the unit operates in Standby mode.

Note: Every event start and end time is set from 0:00 to 24:00 h. The events should be set consistently from the first one at the top of the window.

2.4.3. Functions

In this menu item, the user can activate and set additional unit functions:

- Setpoint sliding;
- OVR function.

- blank box: function is not activated;
 grey box: function is activated.

2.4.3.1. Setpoint sliding

The setpoint can be shifted from -9 °C to +9 °C from the temperature set value at specified by user time period. Event start and end time is set from 0:00 to 24:00 h. When setpoint sliding is active according to set time period, the setpoint sliding icon will be displayed in the main window (see chapter 2.2).

2.4.3.2. OVR function

Air handling units have the OVR ("Override") function. OVR function is intended for remote unit control by an additional external device. After the activation of this function the current mode of operation will be ignored and the unit will operate at a set intensity.

The OVR function can be activated in two ways:

1. **By the external control device.** Connection is described in chapter 1.4. After interconnecting (short-circuiting) the FC contacts (see the electrical diagram), the unit will operate in the selected OVR mode and after disconnection it will return to the previous operation mode.
2. **By control panel.** In this case there is no need for additional connections to external control devices, the function is activated from the panel, and the unit will operate in the chosen OVR mode until the internal timer is active (from 1 to 90 minutes). When this function is active, the intensities of the supplied air and separately for the exhausted air fans can be adjusted from 20 to 100 %.



When OVR function is activated, the modes' buttons in main window are inactive. What is more, the corresponding icon appears in notification bar (see chapter 2.2).

Applications of the OVR function:

- **Maintenance of CO₂ quantity in room** – by adding an additional CO₂ sensor (with relay), the main user-set ventilation rate at higher CO₂ will be switched to the maximum or other intensity set until the room is ventilated, and then again will return to the previously mode.
- **Maintaining relative humidity in the room** – after contacting the external relative humidity sensor (with relay), automatically switching to maximum or different set ventilation intensity the humidity level desired by the user will be maintained.
- **Ventilation on demand** – when the motion sensor is connected to the control contacts, ventilation will be adjusted according to demand, i.e. if people are indoors, ventilation will be carried out according to the set OVR intensity and if there's nobody in the room – the unit will operate according to the main user intensity, for example, the minimum.

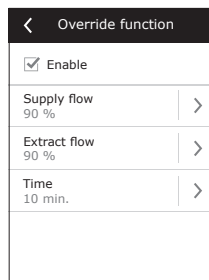
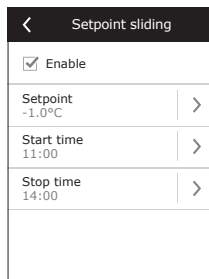
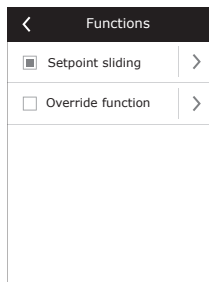

- **Ventilation with additional air extraction** – connection of additional extracting device, for example, a kitchen hood or other extraction device without a separate fan, is intended, thus the air extraction is carried out by the unit itself. After the activation of the function the supply and exhaust air fans start operating at maximum intensity.
- **Negative pressure compensation** – intended for systems where air extraction can be carried out in a separate air extraction fan. Thus, for the compensation of negative pressure in room, the OVR function can be activated by separate control contacts. After the activation of the function, only supply fan starts operating at maximum intensity and the exhaust air fan operates at minimum intensity or goes off.

Note: To make this function work, namely to stop the exhaust air fan in the OVR mode, the jumper No 4 on the automation box should be ON (see chapter 2.5).

2.4.4. Settings

This menu is for air handling unit and the user parameters setting. The user can switch the menu languages, change the screen saver, panel lock, touch sound, season, time and date.

For the air handling unit operating in most economical mode, summer and winter seasons have been provided.

“Summer”: heater operation is blocked but allowed cooler operation.

“Winter”: cooler operation is unavailable but allowed heater operation.

Time and date is required for air handling unit operation planning.

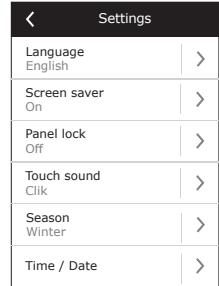

2.4.5. Unit switching on or off

This menu item is intended for unit switching on/off.

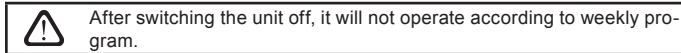

2.5. Configuration of automation functions

Switches (2.5. Picture) on the automatic box can be used for the selection of heat exchanger type, heater and fan, and the OVR function mode. Settings take effect only after rebooting the power supply.

Switch No.	ON	OFF
1	Rotary heat exchanger	Plate heat exchanger
2	Water heater	Electric heater
3	Is not used	Is not used
4	OVR mode when the exhaust air fan is off	Usual OVR mode

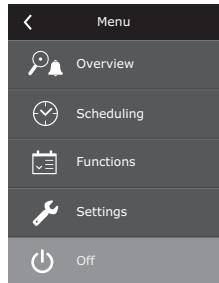

Automation configuration switches

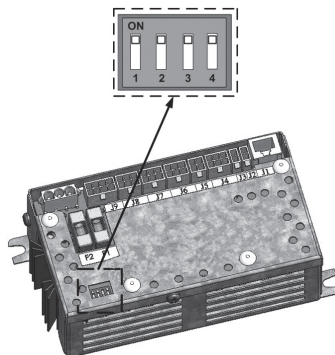

2.5 Picture

2.6. Troubleshooting

If the unit is inoperative:

- Make sure the feeding cable is plugged into an electrical outlet.
- Check all safety fuses of the automatic control block. In case of need, replace the faulty fuses with the new ones of the same electric parameters (fuses parameters are in wiring diagram).
- Make sure there is no failure message in the control panel. If there is a problem, you must first remove it. To remove the problem, follow the table 2.6 describing failures.
- If nothing is shown on the control panel, check the cable that connects the remote panel to the unit.

If air flow is reduced:

- Check set ventilation intensity level (see chapter 2.3.).
- Check air filters' condition. If needed, replace with the new ones.
- Check supply/exhaust air diffusers adjustment.
- Check for clogging outside air intake grille.
- Check if system ducting is not damaged and there are no extraneous things inside.

If supplied air is too cold:

- Check temperature setting (see chapter 2.3.).
- Check if „Winter“ mode is set on the panel.
- Check if there is no failure indication on the control panel (see table 2.6.).
- Check fuse F2 located on the automatic box.



If the unit has been stopped and there is alarm icon (see chapter 2.2.) in the notification bar and sound signal, the failure needs to be eliminated! The failure message is specified in the menu item "Alarms" (see chapter 2.4.1.1.).



Before starting any operations inside the unit, make sure that the unit is switched off and the power supply voltage is shut off.

After the failure has been eliminated and power supply connected, the unit can be switched on only after deleting the failure message. If the failure is successfully eliminated, the unit will operate in the previous mode.

However if the failure has not been eliminated, unit either starts operating and after some time it stops again, or it does not operate and failure message is indicated.

Table 2.6. Alarms indicated on the control panel, their possible causes and elimination methods

Message	Protection tripping description	Possible Failure Cause	Failure Elimination
14B Service time	Depending on the intensity of unit operation, at a certain time a periodic inspection message appears on the control panel.	-	After disconnecting the unit from power supply, it is necessary to carry out periodic inspection of the unit, i.e. to check the air filter clogging and the condition of the heat exchanger, the heater and fans.
19A Low supply air temperature	If the supply air temperature falls below the permitted value: +5 °C, unit will stop operating with 10 min. delay.	Malfunction of the heat exchanger and/or heater.	Check temperature and season settings. Check the heat exchanger and heater operation.
20A Supply air overheating	If the supply air temperature is above the permitted value: +45 °C, unit will stop operating with 10 min. delay.	Malfunction of the heat exchanger and/or heater.	Check temperature and season settings. Check the heat exchanger and heater operation.
13B Heater off	Unit with electric heater has protection from overheating at 70 °C, which can be activated if the heater blow-cooling is insufficient. Unit operation is not terminated.	Heater is disconnected due to low air flow.	When heater cools down, protection restores automatically. It is recommended to increase ventilation intensity level.
4A Electric heater overheating	Unit with electric heater has emergency protection from overheating at 100 °C, which can be activated in case of the heater failure. Unit operation is terminated.	Electric heater overheating protection is on.	It is possible to restore emergency overheating protection with button "RESET" (located on the heater), only if before heater overheating cause has been clarified and eliminated.
27A Return water low temperature	In the unit with water heater, when the water temperature falls below the permitted value of +10°C, the unit will stop operating.	Failure of the hot water preparation and supply function in the heating system.	Check circulation pump and heating system condition, heating valve actuator performance.
28A Frost possibility	In the unit with plate heat exchanger, if the freezing protection of the heat exchanger is activated and is not restored, the unit will stop operating.	Temperature of the air passing through plate heat exchanger, dropped lower allowable level.	Check by-pass damper condition and actuator performance. It is recommended to decrease ventilation level.
3A Rotor stopping	When there is no signal from the rotor's rotation sensor, if the "Winter" season is set, the unit will stop operating in 2 min.	The belt is broken, failure of the rotor motor or rotor sensor.	Check rotor drive and rotation sensor condition.
11B Rotor stopping	When there is no signal from the rotor's rotation sensor, if the "Summer" season is set, the warning message appears in 2 min. on the control panel. The unit operation is not terminated.	The belt is broken, failure of the rotor motor or rotor sensor.	Check rotor drive and rotation sensor condition.
9A B1 sensor failure	When temperature exceeds the maximum permitted limits: -30 °C...+75 °C, the unit stops operating immediately.	Supply air temperature sensor is not connected or broken down.	It is necessary to check sensor connections or change the sensor.

UAB KOMFOVENT

VILNIUS Ozo g. 10, LT-08200
Tel. +370 (5) 2779 701
Mob. tel. 8-685 44658
el. p. info@komfovent.com

KAUNAS Taikos pr. 149, LT-52119
Tel.: (8-37) 473 153, 373 587
Mob. tel. 8 685 63962
el. p. kaunas@komfovent.com

KLAIPĖDA Dubysos g. 25, LT-91181
Mob. tel.: 8 685 93706, 8 685 93707
el. p. klaipeda@komfovent.com

ŠIAULIAI Metalistų g. 6H, LT-78107
Tel. (8-41) 500090,
mob. tel. +370 685 93700
el. p. siauliai@komfovent.com

PANEVĖŽYS Beržų g. 44, LT-36144
Mob. tel. 8 640 55988
el. p. panevezys@komfovent.com

EXPORT & SALES DEPARTMENT
Ph.: +370 (5) 205 1579, 231 6574
Fax +370 (5) 230 0588
export@komfovent.com

**GARANTINIO APTARNAVIMO SK. /
SERVICE AND SUPPORT**
Tel. / Ph. +370 (5) 200 8000,
mob. tel. / mob. ph.: +370 652 03180
service@komfovent.com

www.komfovent.com

ООО «АМАЛБА-Р»

Россия, Москва
ул. Выборгская д. 16,
стр. 1, 2 этаж, 206 офис
тел./факс +7 495 640 6065,
info.msk@komfovent.com
www.komfovent.ru

ООО «АМАЛБА-ОКА»

390017 г. Рязань
Рязжское шоссе, 20 литера Е, пом Н6
тел. +7 4912 950575, +7 4912 950672,
+7 4912 950648
info.oka@komfovent.com
www.komfovent.ru

ИООО «Комфoвент»

Республика Беларусь, 220125 г. Минск,
ул. Уручская 21 – 423
Тел. +375 17 286 5297, 266 6327
info.by@komfovent.com
www.komfovent.by

PARTNERS

AT	J. PICHLER Gesellschaft m. b. H.	www.pichlerluft.at
AU	Pacific HVAC	www.pacificvac.com
BE	Ventilair group	www.ventilairgroup.com
	ACB Airconditioning	www.acbairco.be
CZ	REKUVENT s.r.o.	www.rekuvent.cz
CH	WESCO AG	www.wesco.ch
	SUDCLIMATAIR SA	www.sudclimatair.ch
	CLIMAIR GmbH	www.komfovent.com/en/business/ more/contact-us/
DK	UNIQ COMFORT ApS	www.uniqcomfort.dk
	AIR2TRUST	www.air2trust.com
EE	BVT Partners	www.bvtpartners.ee
FR	AERIA	www.aeria-france.fr
GB	ELTA FANS	www.eltafans.com
HR	Microclima	www.microclima.hr
HU	AIRVENT Légtechnikai Zrt.	www.airvent.hu
	Gevent Magyarország Kft.	www.gevent.hu
	Merkapt	www.merkapt.hu
IR	Fantech Ventilation Ltd	www.fantech.ie
IS	Blikk & Tækniþjónustan ehf	www.bogt.is
	Hitataekni ehf	www.hitataekni.is
NL	Ventilair group	www.ventilairgroup.com
	DECIPOL-Vortvent	www.vortvent.nl
NO	Ventistål AS	www.ventistal.no
	Thermo Control AS	www.thermocontrol.no
PL	Ventia Sp. z o.o.	www.ventia.pl
SE	Nordisk Ventilator AB	www.nordiskventilator.se
SI	Agregat d.o.o	www.agregat.si
SK	TZB produkt, s.r.o.	www.tzbprodukt.sk

Komfovent AB

Ögärdesvägen 12B
433 30 Partille, Sverige
Phone +46 31 487752
info_se@komfovent.com
www.komfovent.se

Komfovent Oy

Muuntotie 1 C1
FI-01 510 VANTAA
+358 (0) 40 8263 500
info_fi@komfovent.com
www.komfovent.com

Komfovent GmbH

Konrad-Zuse-Str. 2a, 42551 Velbert,
Deutschland
Mob. ph. +49 (0) 2051/6051180
info@komfovent.de
www.komfovent.de

Komfovent SIA

Katlakalna iela 9,
LV-1073 Riga
Tel. +371 67 20 1572
Fakss +371 67 20 1570
info@komfovent.lv
www.komfovent.lv